

Installation

A UNDER BENCH / TOP VENT

Model WAM30 Warrior Mini Bar Fridge



Fridge Specs: 405mm W x 445mm D x 520mm H
Cabinet Minimum Internal Width: 435mm

OPTIONAL - Bench Top Vent

Model WAVE350

Avail in Black and Stainless Steel

Dimensions: 100mm D x 350mm W

-  Arrows indicate minimum width / height for airflow
-  Blue arrows indicate airflow ventilation
-  Dark Grey indicate cabinetry & benchtop.

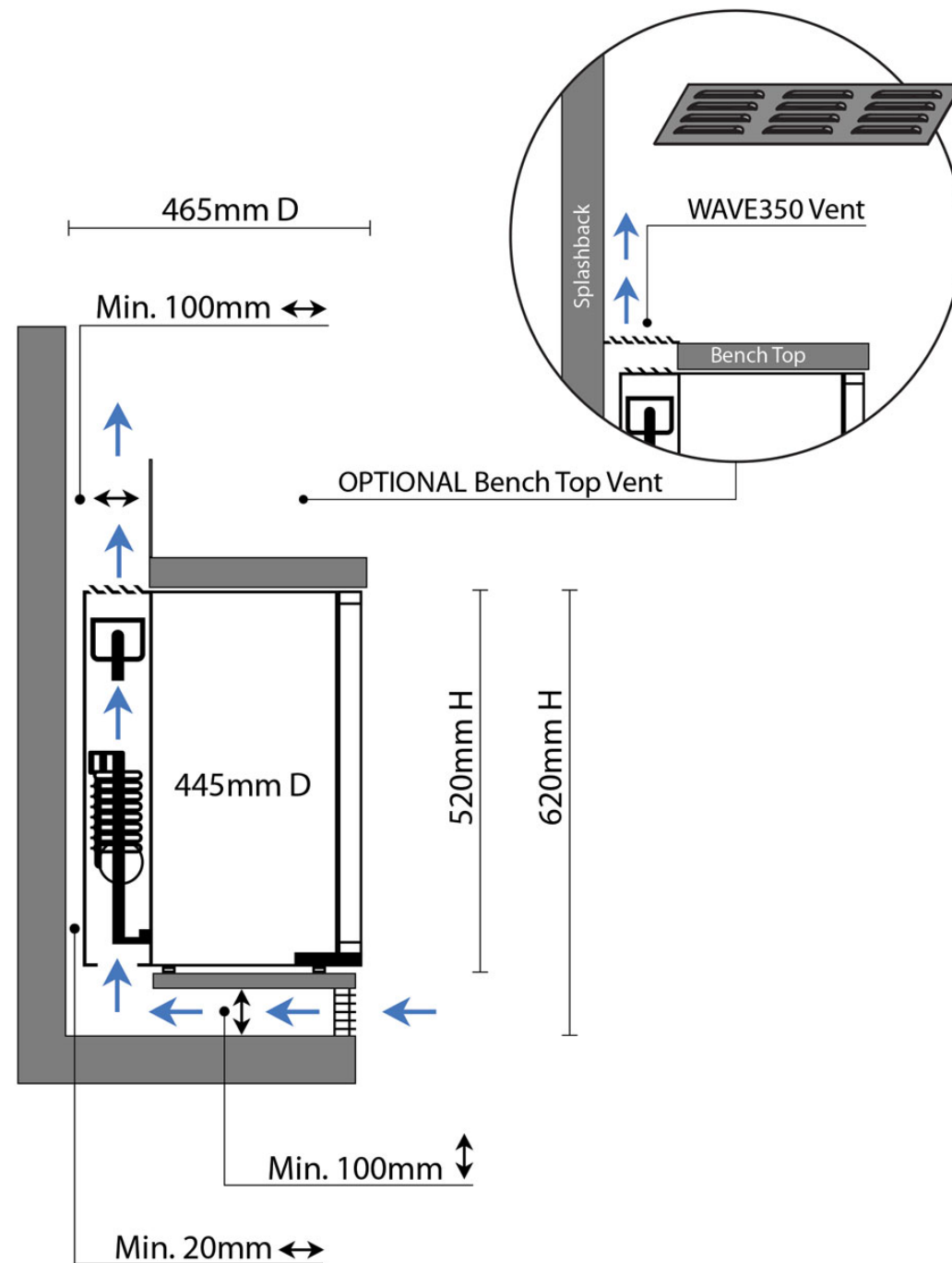

1300 232 616

WARRIORFRIDGES.COM.AU

Installation

A UNDER BENCH / TOP VENT

Model WAVE350 Warrior Louvered Vent

OPTIONAL - Bench Top Vent
Dimensions: 350mm W x 100mm D
Avail in Black and Stainless Steel

Designed for Integration in Top of Bench
Install with Warrior Mini Fridge Models:

WAM30G, WAM30, WAM40G, WAM40, WAM50G, WAM50

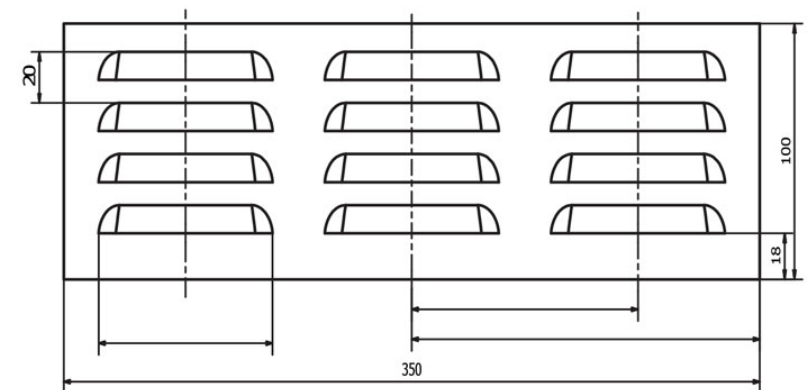
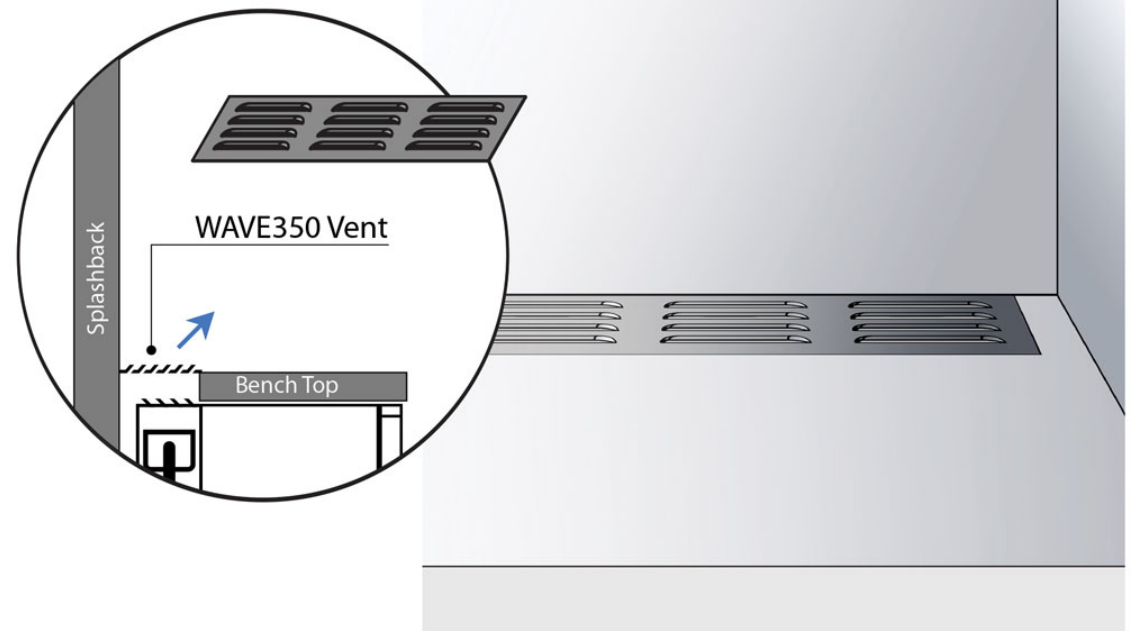
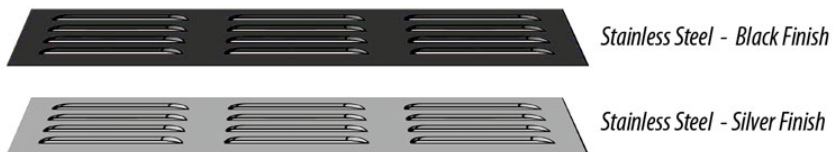

Top Elevation - 100mm x 350mm



1300 232 616



WARRIORFRIDGES.COM.AU

Installation

B ABOVE BENCH / FRONT VENT

Model WAM30 Warrior Mini Bar Fridge

Fridge Specs: 405mm W x 445mm D x 520mm H
Cabinet Minimum Internal Width: 435mm

-  Arrows indicate minimum width / height for airflow
-  Blue arrows indicate airflow ventilation
-  Dark Grey indicate cabinetry & benchtop.

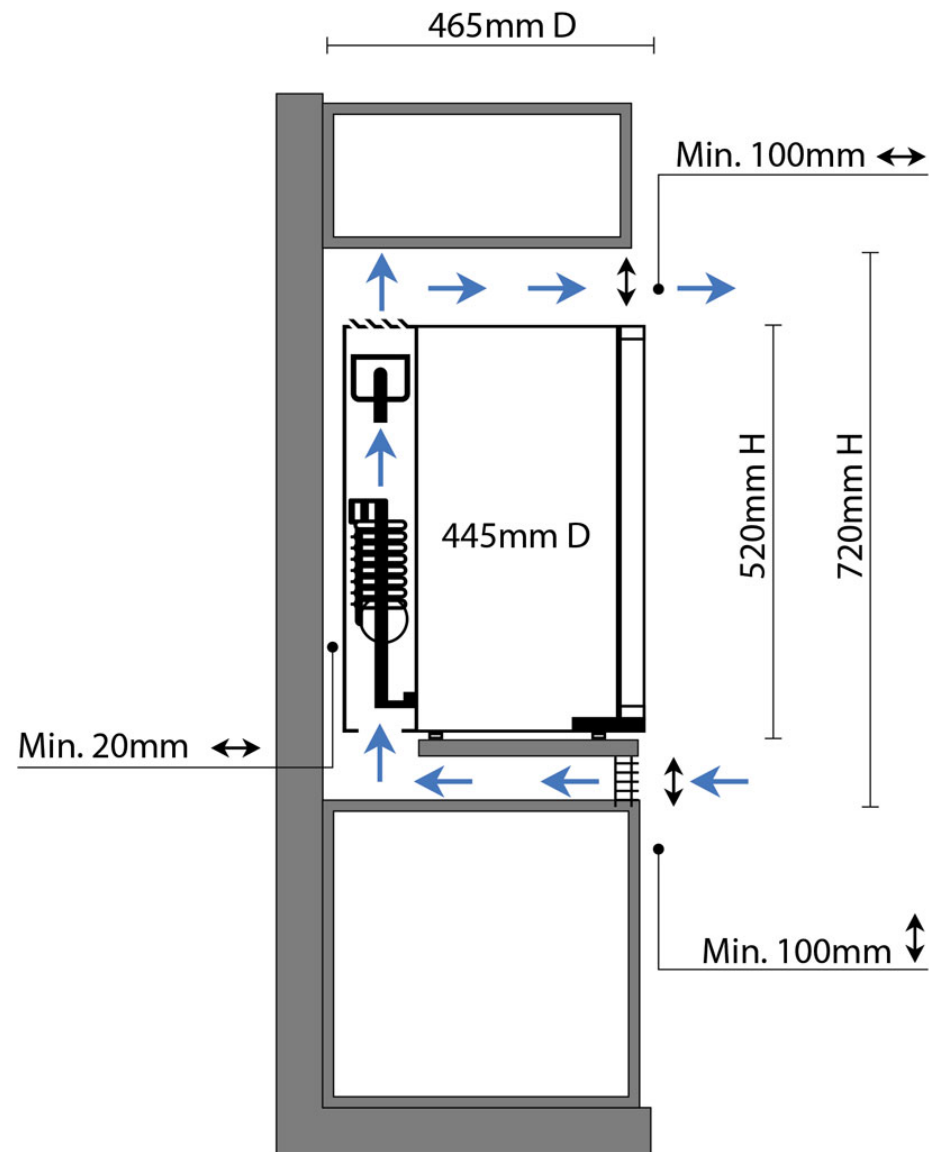

WARRIOR

1300 232 616



WARRIORFRIDGES.COM.AU

Installation

C ABOVE BENCH / REAR VENT

Model WAM30 Warrior Mini Bar Fridge

Fridge Specs: 405mm W x 445mm D x 520mm H
Cabinet Minimum Internal Width: 435mm

-  Arrows indicate minimum width / height for airflow
-  Blue arrows indicate airflow ventilation
-  Dark Grey indicate cabinetry & benchtop.

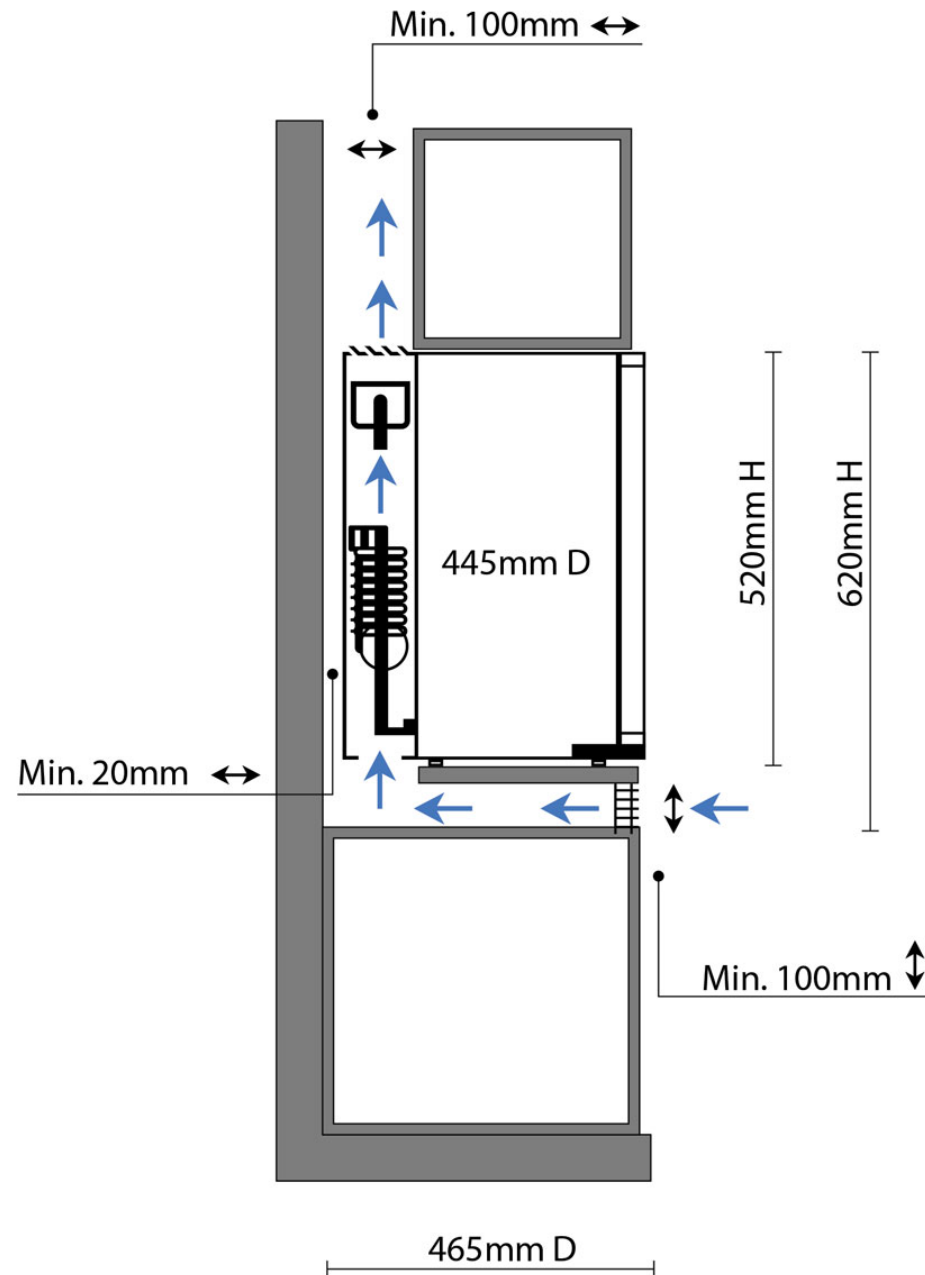

1300 232 616

WARRIORFRIDGES.COM.AU